

Panasonic

Cordless Phone

Model No. KX-TC1000B/KX-TC1001W
KX-TC1401B/KX-TC1401W
KX-TC1401G/KX-TC1401F
KX-TC1401V

Pulse-or-tone dialing capability

Operating Instructions



**SOUND CHARGER
PLUS**

Contents by Section

- 1 Getting Started
- 2 Making/Answering Calls
- 3 Speed Dialer
- 4 One-touch Dialer
- 5 Special Features
- 6 Things You Should Know
- 7 Referencia rápida

Charge the battery fully
before initial use.

KX-TC1000B/KX-TC1001W:
for 10 hours

KX-TC1401B/KX-TC1401W

KX-TC1401G/KX-TC1401F

KX-TC1401V:

for 15 hours

PLEASE READ BEFORE USE AND SAVE.

1-A Accessories

- AC Adaptor.....one
Order No. KX-TCA1-G

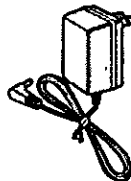

- Telephone Line Cord
.....one



• To order accessories, call
1-800-332-5368.

1-B Location of Controls

Handset

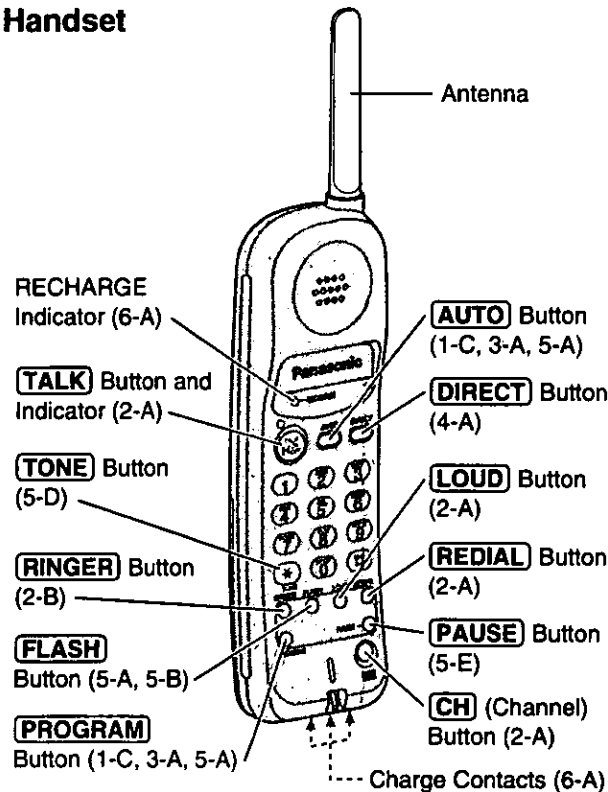

Base unit

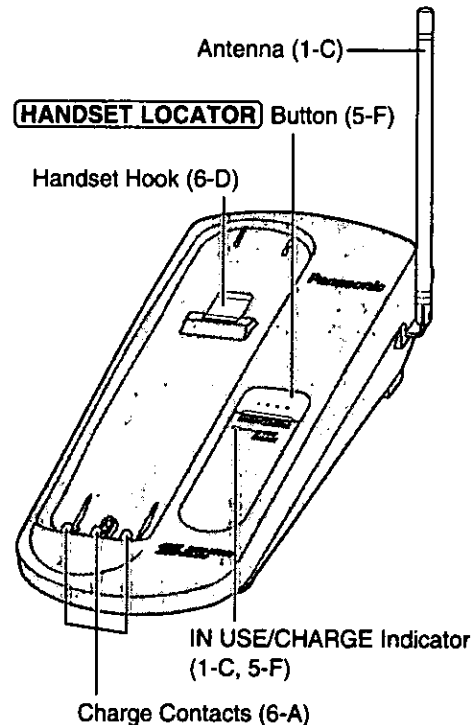

1-C Settings

1 Connect as shown.

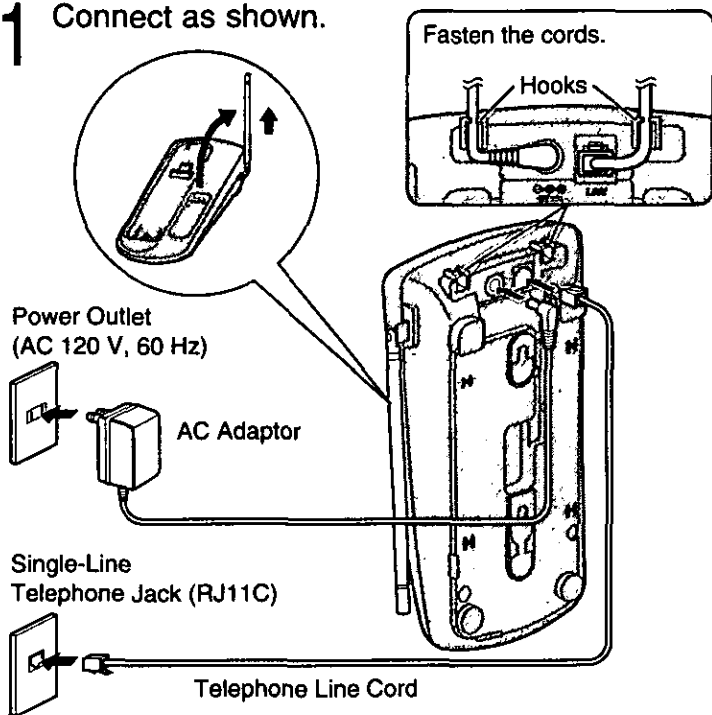

- USE ONLY WITH Panasonic AC ADAPTOR KX-TCA1 (Order No. KX-TCA1-G).
- The AC adaptor must remain connected at all times. (It is normal for the adaptor to feel warm during use.)
- To connect a standard telephone on the same line, see section 6-F.

2 Raise the antenna.
Extend it fully. (KX-TC1000B/KX-TC1001W only)



3 Charge the battery.
KX-TC1000B/KX-TC1001W:
for 10 hours
KX-TC1401B/KX-TC1401W
KX-TC1401G/KX-TC1401F
KX-TC1401V :
for 15 hours

- See section 6-A for more details.
- The IN USE/CHARGE indicator lights.

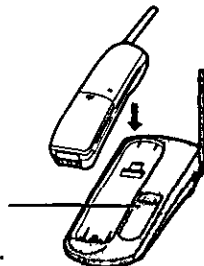

To select the dialing mode TONE (preset) or PULSE

You can program the dialing mode by using the handset near the base unit. The TALK indicator light must be off before programming.

Press **PROGRAM** ➔ **AUTO** ➔ OR ➔ **PROGRAM**.
twice (PULSE)
* twice (TONE).

- To cancel during programming, press **PROGRAM**, then start from the beginning.
- If 3 beeps sound during programming, a wrong key was pressed. Restart from the beginning.
- If a power failure occurs, the mode will return to the factory preset (TONE). Reprogram if necessary.

2-A Making Calls

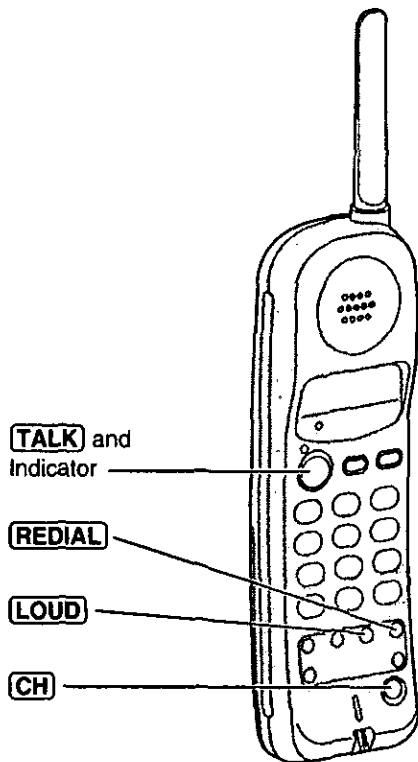

- 1 Press **TALK**.
 - The TALK indicator lights.
 - If an alarm tone sounds, see 6-E.
- 2 Dial a telephone number.
- 3 To hang up, press **TALK** or place the handset on the base unit.
 - The indicator light goes out.

OPERATING DISTANCE

For best operating performance, see section 6-C.

To redial the last number dialed

Press **TALK** ➔ **REDIAL**.

To select the receiver volume

Press **LOUD** while talking.

- Each time you press the button, the volume level will change from MEDIUM (preset) to HIGH to LOW.

If noise interferes with the conversation

Press **CH** to select a clearer channel or move closer to the base unit.

Lighted handset keypad

(KX-TC1000B/KX-TC1401G/
KX-TC1401F/KX-TC1401V only)

The handset dialing buttons will light when you press a button or lift the handset off the base unit, and flash when a call is received. The lights will go out about 10 seconds after pressing a button, lifting the handset or answering a call.

2-B Answering Calls

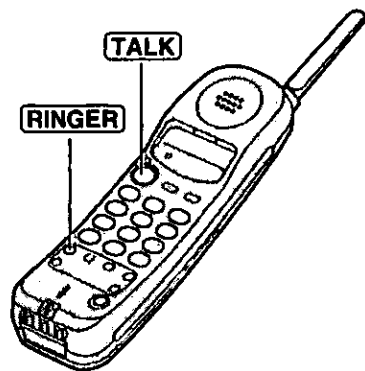

If the handset is off the base unit,
press **TALK**.

- You can also answer a call by pressing any dialing button **0** to **9**, ***** or **#** (- Any Key Talk).

OR

If on the base unit,
just lift up.

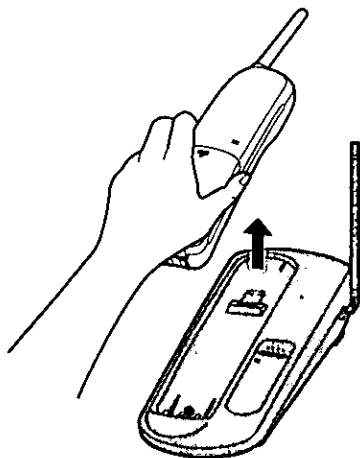

Selecting the ringer volume

The TALK indicator light must be off.

- To select **HIGH** (preset) or **LOW**, press **RINGER**.
(Each time you press the button, the selected volume will ring and the ringer volume will change.)
- To turn the ringer **OFF**, press and hold **RINGER** until 2 beeps sound.
- To turn the ringer **ON**, press **RINGER**.
The ringer will sound at the HIGH level.

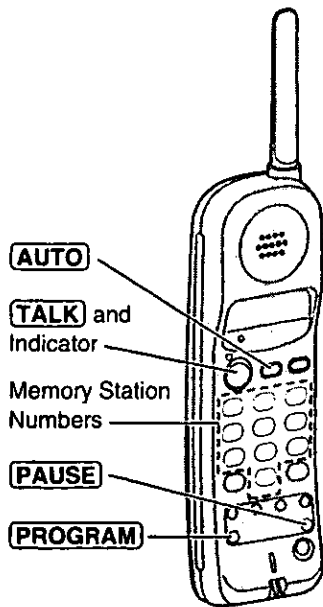

3-A Storing Phone Numbers in Memory

You can store up to 10 phone numbers in the handset. The dialing buttons (0 to 9) function as memory stations. The TALK indicator light must be off before programming.

- 1 Press **PROGRAM**.
 - The TALK indicator flashes.
- 2 Enter a phone number up to 22 digits.
- 3 Press **AUTO**.
- 4 Press a memory station number (0 to 9).
 - A beep sounds.
 - To store other numbers, repeat steps 1 through 4.

• If a pause is required for dialing, press **PAUSE** where needed. Pressing **PAUSE** counts as one digit (5-E).

If you misdial

Press **PROGRAM** to end storing. ➔
➔ Restart from step 1.

To erase a stored number

Press **PROGRAM** ➔ **AUTO** ➔
➔ the memory station number (0 to 9)
for the phone number to be erased.
• A beep sounds.

3-B Dialing a Stored Number

Press **TALK** ➔ **AUTO** ➔ the memory station number (0 to 9).

• If your line has rotary or pulse service, any access numbers stored after pressing **TO** will not be dialed.

4 One-Touch Dialer

4-A Storing a Phone Number in the DIRECT Button

You can store a phone number in the **DIRECT** button. The stored number is dialed with a one-touch operation.

The **TALK** indicator light must be off before programming.

1. Press **PROGRAM**.
 - The **TALK** indicator flashes.
2. Enter a phone number up to 22 digits.
 - If you misdial, press **PROGRAM**, then start from step 1.
3. Press **DIRECT**.
 - A beep sounds.
 - If a pause is required for dialing, press **PAUSE** where needed. Pressing **PAUSE** counts as one digit (5-E).

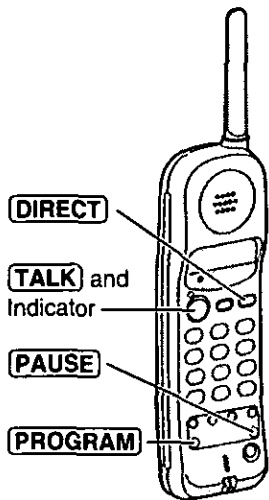

4-B Dialing a Stored Number in the DIRECT Button

Press **TALK** ➔ **DIRECT**.

- If your line has rotary or pulse service, any access numbers stored after pressing **TONE** will not be dialed.
- To erase a stored number; Press **PROGRAM** ➔ **DIRECT**.

5 Special Feature

5-A FLASH Button

Pressing **FLASH** allows you to use special features of your host PBX such as transferring an extension call or accessing special telephone services (optional), such as call waiting.

Selecting the flash time

The flash time depends on your telephone exchange or host PBX. You can select the following flash times: "90, 100, 110, 250, 300, 400, 600, 700 msec (milliseconds)", **using the handset near the base unit**. Your phone comes from the factory set to "700 msec".

The TALK indicator light must be off before programming.

Press **PROGRAM** → **Dialing button (1 to 8)** → **AUTO** → **FLASH**.

1: 90 msec **2**: 100 msec **3**: 110 msec
4: 250 msec **5**: 300 msec **6**: 400 msec
7: 600 msec **8**: 700 msec

- If 3 beeps sound after programming, a wrong key was pressed. Restart from the beginning.
- If a power failure occurs, the setting will return to the factory preset (700 msec). Reprogram if necessary.
- If you are connected via a PBX, a longer flash time may be necessary to use PBX functions (transferring a call, etc.). Consult your PBX installer for the correct setting.

5-B For Call Waiting Service Users

Press **FLASH** if you hear a call-waiting tone while talking.

- The first call is put on hold and you can answer the second call.
- To return to the first caller, press **FLASH** again.
- If this function does not operate properly, the flash time may not be set correctly. Consult your telephone company for details. See section 5-A on how to adjust the flash time.

5-C Automatic Security Code Setting

Whenever you place the handset on the base unit, the unit automatically selects one of a million security codes. These codes help prevent the unauthorized use of your telephone line by another cordless telephone.

5-D Temporary Tone Dialing (For Rotary or Pulse Service Users)

Press **TONE** before entering access numbers which require tone dialing.

- The dialing mode changes to tone. You can enter numbers to access an answering service, electronic banking service, etc. When you hang up, the mode will return to pulse.
- Access numbers entered after pressing **TONE** will not be included when redialing.

5-E How to use the PAUSE Button (For Analog PBX Line/Long Distance Service Users)

We recommend you press **PAUSE** if a pause is required for dialing with a PBX or to access a long distance service.

Ex: Line access number **9** (PBX)

9 → **PAUSE** → Phone number

- Pressing **PAUSE** once creates a 3.5 second pause. This prevents misdialing when you redial or dial a stored number.
- Pressing **PAUSE** more than once increases length of the pause between numbers.

5-F Handset Locator

You can locate the handset or page the handset user with beep tones.

- 1 Press **HANDSET LOCATOR** on the base unit.
 - The IN USE/CHARGE indicator flashes and the handset beeps for 1 minute.
- 2 To stop paging, press **HANDSET LOCATOR** again or press **TALK** twice on the handset.

6 Things You Should Know

6-A Battery

Recharge

When the RECHARGE indicator flashes or the unit beeps intermittently, place the handset on the base unit to recharge the battery.

KX-TC1000B/KX-TC1001W: for 10 hours
KX-TC1401B/KX-TC1401W/KX-TC1401G
KX-TC1401F/KX-TC1401V: for 15 hours

•If you DO NOT recharge the handset battery for more than 30 minutes, the RECHARGE indicator will continue to flash.

Battery information

After your Panasonic battery is fully charged:

Operation	Approx. battery life
While in use (TALK)	Up to about 8 hours
While not in use (Stand-By)	Up to about 30 days (KX-TC1000B/KX-TC1001W) Up to about 21 days (KX-TC1401B/KX-TC1401W KX-TC1401G/KX-TC1401F/KX-TC1401V)

- Battery life may vary depending on usage conditions and ambient temperature.
- The battery cannot be overcharged.
- **Clean the handset and the base unit charge contacts with a soft dry cloth once a month. Clean more often if the unit is subject to grease, dust or high humidity.** If not, the battery may not charge properly.
- If the battery is fully charged, you do not have to place the handset on the base unit until the RECHARGE indicator flashes. This will maximize the battery life.

6-B Battery Replacement

If the RECHARGE indicator flashes after being fully charged, replace the battery with a new Panasonic battery.

Order No. P-P305 (for KX-TC1000B/KX-TC1001W)
Order No. P-P501(KX-A36) (for KX-TC1401B/KX-TC1401W/
KX-TC1401G/KX-TC1401F/KX-TC1401V)

To order, call the accessories telephone number in section 1-A.
To prevent memory loss, replace within 3 minutes.

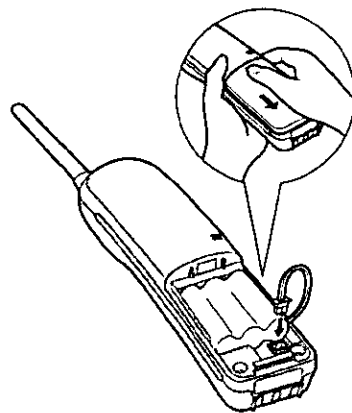

- 1 Remove the cover by sliding it while pressing the arrow.
- 2 Replace the battery, then close the cover.
- 3 Be sure to charge the new battery.

KX-TC1000B/KX-TC1001W:
for 10 hours
KX-TC1401B/KX-TC1401W/
KX-TC1401G/KX-TC1401F/
KX-TC1401V:
for 15 hours

Attention:

The product you have purchased is powered by a nickel-cadmium battery which is recyclable. At the end of its useful life, under various state and local laws, it is illegal to dispose of this battery into your municipal waste stream. Please call 1-800-8-BATTERY for information on how to recycle this battery.



6-C Base Unit Location

Calls are transmitted between the base unit and the handset using wireless radio waves. For maximum distance and noise free operation, the recommended base unit location is:

Away from electrical appliances such as a TV, radio, or personal computer.

In a HIGH and CENTRAL location with no obstructions such as walls.

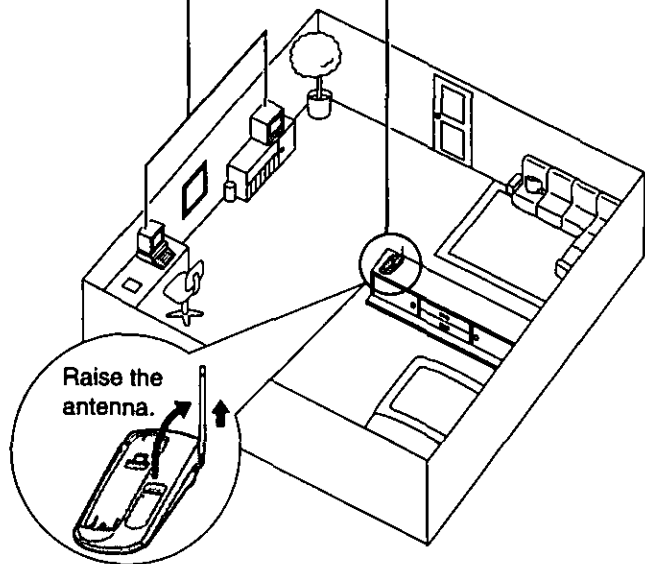

6-D Wall Mounting

This unit can be mounted on a wall phone plate.

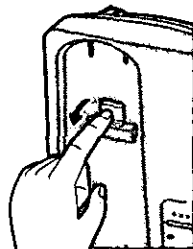

1 Pull down the handset hook until it locks, so the tab holds the handset.

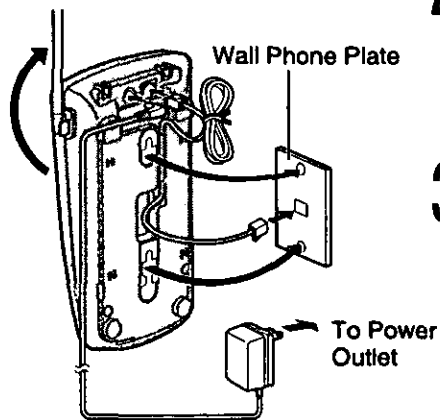

2 Connect the AC adaptor and telephone line cord.

3 Mount the unit, then slide down.
• Raise the antenna.

6-E Before Requesting Help

Problem	Remedy	Problem	Remedy
The unit does not work.	<ul style="list-style-type: none"> • Check the settings (1-C). • Charge the battery fully (6-A). • Clean the charge contacts and charge again (6-A). • Install the battery properly (6-B). • Place the handset on the base unit and unplug the AC adaptor to reset. Plug in, then try again. • Re-insert the handset battery within 3 minutes to avoid memory loss and place the handset on the base unit. Then try again. 	You cannot store a phone number in memory.	<ul style="list-style-type: none"> • You cannot store a number while the unit is in the talk mode. • Do not pause for over 60 seconds while storing.
An alarm tone sounds when you press TALK.	<ul style="list-style-type: none"> • You are too far from the base unit. Move closer and try again. • Place the handset on the base unit and try again. • Plug in the AC adaptor. • Raise the base unit antenna. 	You cannot redial by pressing REDIAL.	<ul style="list-style-type: none"> • The redial function does not work right after programming the flash time (5-A) and storing phone numbers in the speed dialer or one-touch dialer (3-A, 4-A). • Access numbers entered after pressing TONE will not be included when redialing (5-D). • If the last number dialed was more than 32 digits long, the number will not be redialed.
Static, sound cuts in/out, fades. Interference from other electrical units.	<ul style="list-style-type: none"> • Locate the handset and the base unit away from other electrical appliances (6-C). • Move closer to the base unit. • Raise the base unit antenna. • Press CH to select a clearer channel. 	HANDBSET LOCATOR does not function.	<ul style="list-style-type: none"> • The handset is too far from the base unit or is engaged in an outside call.
The unit does not ring.	<ul style="list-style-type: none"> • The ringer volume is set to OFF. Press RINGER while the TALK indicator light is off (2-B). 	The RECHARGE Indicator flashes or the unit beeps intermittently.	<ul style="list-style-type: none"> • Charge the battery fully (6-A).
While storing a phone number, the unit starts to ring.	<ul style="list-style-type: none"> • To answer the call, press TALK. The program will be canceled. Store the number again. 	You charged the battery fully, but the RECHARGE Indicator flashes.	<ul style="list-style-type: none"> • Clean the charge contacts and charge again (6-A). • Install a new battery (6-B).
		The IN USE/CHARGE Indicator light never goes out while charging.	<ul style="list-style-type: none"> • This is normal.
		If you cannot solve your problem	<ul style="list-style-type: none"> • Call our customer call center at 1-800-211-PANA(7262).

6-F Adding Another Phone

This unit will not function during a power failure. To connect a standard telephone on the same line, use the Panasonic T-adaptor (KX-J66). To order, call the accessories telephone number in section 1-A.

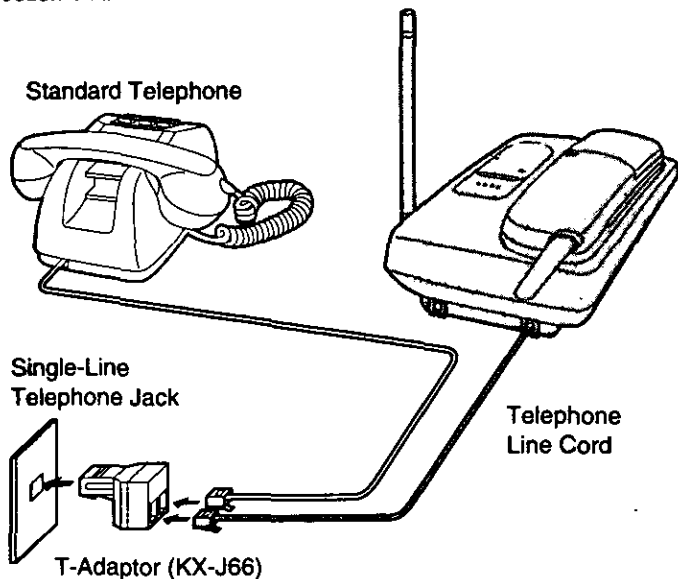

6-G Helpful Information

- **Environment**—do not place the unit in a room where the temperature is less than 5°C (41°F) or greater than 40°C (104°F). Allow 10 cm (4") clearance around the unit for proper ventilation. Avoid excessive smoke, dust, mechanical vibration, shock, or direct sunlight.
- **Routine care**—wipe the unit with a soft cloth. Do not use benzine, thinner, or any abrasive powder. When you leave the unit unused for a long period of time, unplug the AC adaptor from the outlet.
- **If there is any trouble**—disconnect the unit from the telephone line and connect a known working phone. If the known working phone operates properly, have your unit repaired by one of the authorized Panasonic Factory Service Centers. If the known working phone does not operate properly, consult your telephone company.

- This cordless telephone is designed for use in the United States of America. Sale or use of this product in other countries may violate local laws.
- Ce téléphone sans fil est conçu pour être utilisé aux États-Unis d'Amérique. La vente ou l'emploi de cet appareil dans certains autres pays peut constituer une infraction à la législation locale.
- Este teléfono sin cordón fue elaborado para uso en los Estados Unidos de América. La venta o el empleo de este producto en ciertos países puede constituir violación de la legislación local.
- このコードレス電話機は、日本国外での使用を目的として設計されており、日本国内での使用は法律違反となります。従って、当社では日本国内においては原則として修理などのサービスは致しかねます。

7-A Preparación

- 1 Conecte como se muestra.

Para obtener el máximo alcance de operación, ponga la unidad base en un lugar **ELEVADO y CÉNTRICO** sin obstrucciones ni interferencias de aparatos eléctricos.

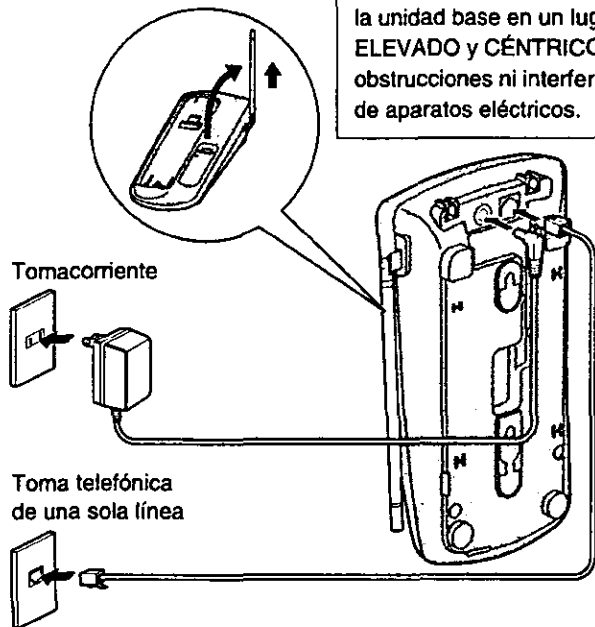

- El adaptador de CA debe permanecer conectado en todo momento.

- 2 Levante la antena.
Extienda completamente la antena.
(KX-TC1000B/KX-TC1001W solamente)

- 3 Cargue la batería.
KX-TC1000B/KX-TC1001W:
durante 10 horas
KX-TC1401B/KX-TC1401W/
KX-TC1401G/KX-TC1401F/
KX-TC1401V:
durante 15 horas
• El indicador IN USE/CHARGE se encenderá.

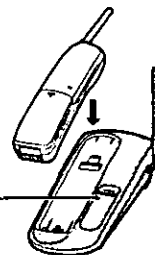

Selección del modo de marcación por TONO (preajustado) o PULSACIÓN

Utilizando la unidad portátil cerca de la unidad base usted puede programar el modo de marcación. El indicador TALK deberá estar apagado antes de programar.

Presione **PROGRAM** ➔ **AUTO** ➔ **0** ➔ **PROGRAM**.
dos veces (PULSACIÓN)
* dos veces (TONO)

- Si se produce un corte de electricidad, el modo volverá al prefijado (TONO). Vuelva a programar si fuera necesario.

7-B Funcionamiento

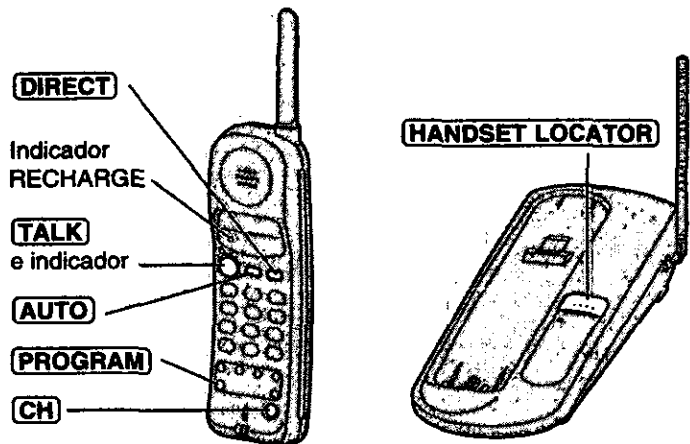

- Cuando el indicador RECHARGE parpadee o la unidad emita pitidos intermitentemente, cargue la batería.

Para hacer llamadas

Presione **TALK** ➔ Marque un número de teléfono. ➔ Cuando termine, presione **TALK** o ponga la unidad portátil en la unidad base.

- Si interfiere ruido con su conversación, presione **CH** para seleccionar un canal más claro o acérquese a la unidad base.

Contestación de llamadas

Si la unidad portátil no está en la unidad base, presione **TALK** o cualquier botón de marcación (**0** a **9**, ***** o **#**).

Si está en la unidad base, levántela solamente.

Marcación rápida

Se pueden memorizar hasta 10 números de teléfono en la unidad portátil. Los botones de marcación (**0** a **9**) funcionan como estaciones de memoria. El indicador TALK deberá estar apagado antes de programar.

Para almacenar números de teléfono en la memoria

Presione **PROGRAM** ➔ **Número de teléfono (hasta 22 dígitos)** ➔

➔ **AUTO** ➔ **Número de estación**.

Para marcar un número almacenado

Presione **TALK** ➔ **AUTO** ➔ **Número de estación**.

Marcación de un toque

Usted puede almacenar un número de teléfono en el botón **DIRECT**. El indicador TALK deberá estar apagado antes de programar.

Para almacenar un número de teléfono en el botón DIRECT

Presione **PROGRAM** ➔ **Número de teléfono (hasta 22 dígitos)** ➔ **DIRECT**.

Para marcar un número almacenado en el botón DIRECT

Presione **TALK** ➔ **DIRECT**.

Localización de la unidad portátil

Presione **HANDSET LOCATOR** en la unidad base.

- La unidad portátil emite pitidos durante 1 minuto.
- Para detener la localización, presione de nuevo **HANDSET LOCATOR** o presione dos veces **TALK** en la unidad portátil.

Attach your purchase receipt here.

For your future reference

Serial No.

Date of purchase

(found on the bottom of the unit)

Name and address of dealer

For product service

- Panasonic Servicenters are listed in the servicenter directory.
- For assistance, please call: 1-800-211-PANA (7262) or send e-mail to: consumerproducts@panasonic.com

When you ship the product

- Carefully pack your unit, preferably in the original carton.
- Attach a letter, detailing the symptom, to the outside of the carton.

Symptom

- Send the unit to an authorized servicenter, prepaid and adequately insured.
- Do not send your unit to the Panasonic Consumer Electronics Company listed below or to executive or regional sales offices. These locations do not repair consumer products.

**Panasonic Consumer Electronics Company,
Division of Matsushita Electric Corporation of America
One Panasonic Way, Secaucus, New Jersey 07094**

**Panasonic Sales Company,
Division of Matsushita Electric of Puerto Rico, Inc.
Ave. 65 de Infantería, Km. 9.5, San Gabriel Industrial Park
Carolina, Puerto Rico 00985**

Printed in USA

PQQX12677YB

AR0200VR1050